

# *Plans cotés*

# *SYMBIOPHONY*

## Appui pose neuf

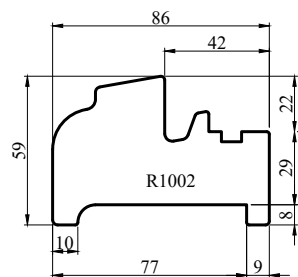

## Appui standard

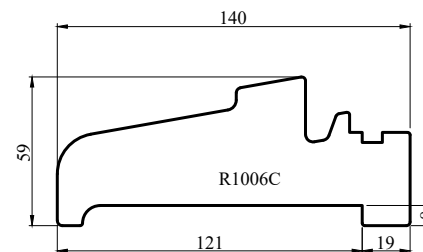
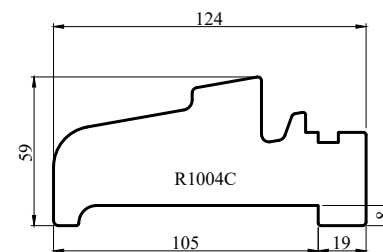
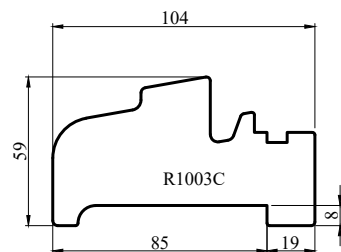
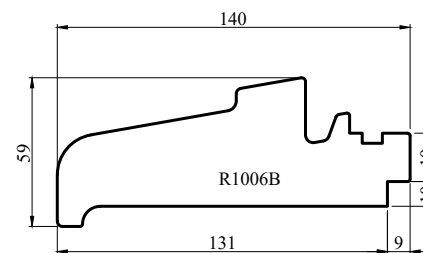
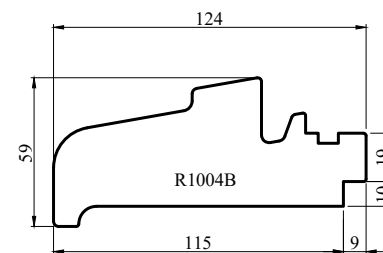
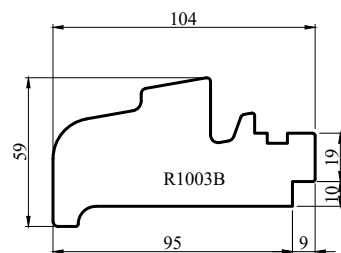
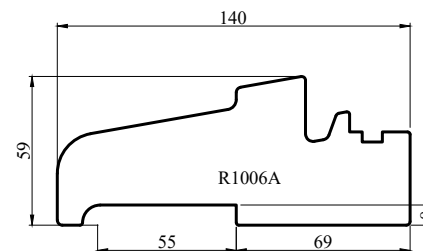
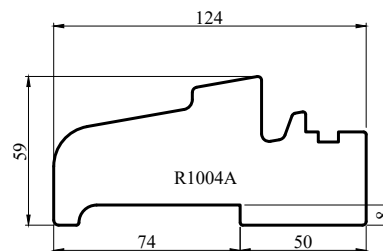
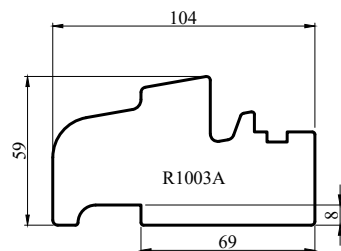
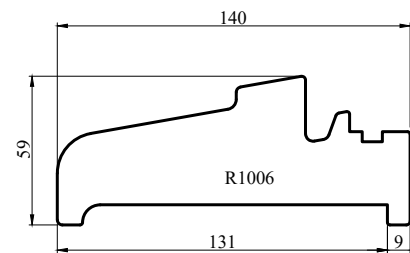
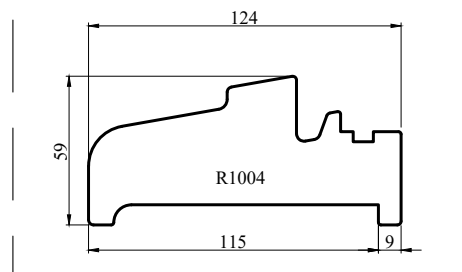
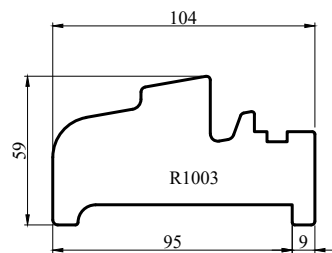

Emplacement :

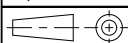

Echelle : 1/3

Date : 22/05/2023

Des. : ML

CE DOCUMENT EST LA PROPRIETE DES MENUISERIES ELVA. IL NE PEUT ETRE REPRODUIT OU COMMUNIQUE SANS SON AUTORISATION

Ind. 0

N° plan : PLC-SYMBIOPHONY-1

Gamme SYMBIOPHONY --- B04 - Appui standard

## Appui rénovation

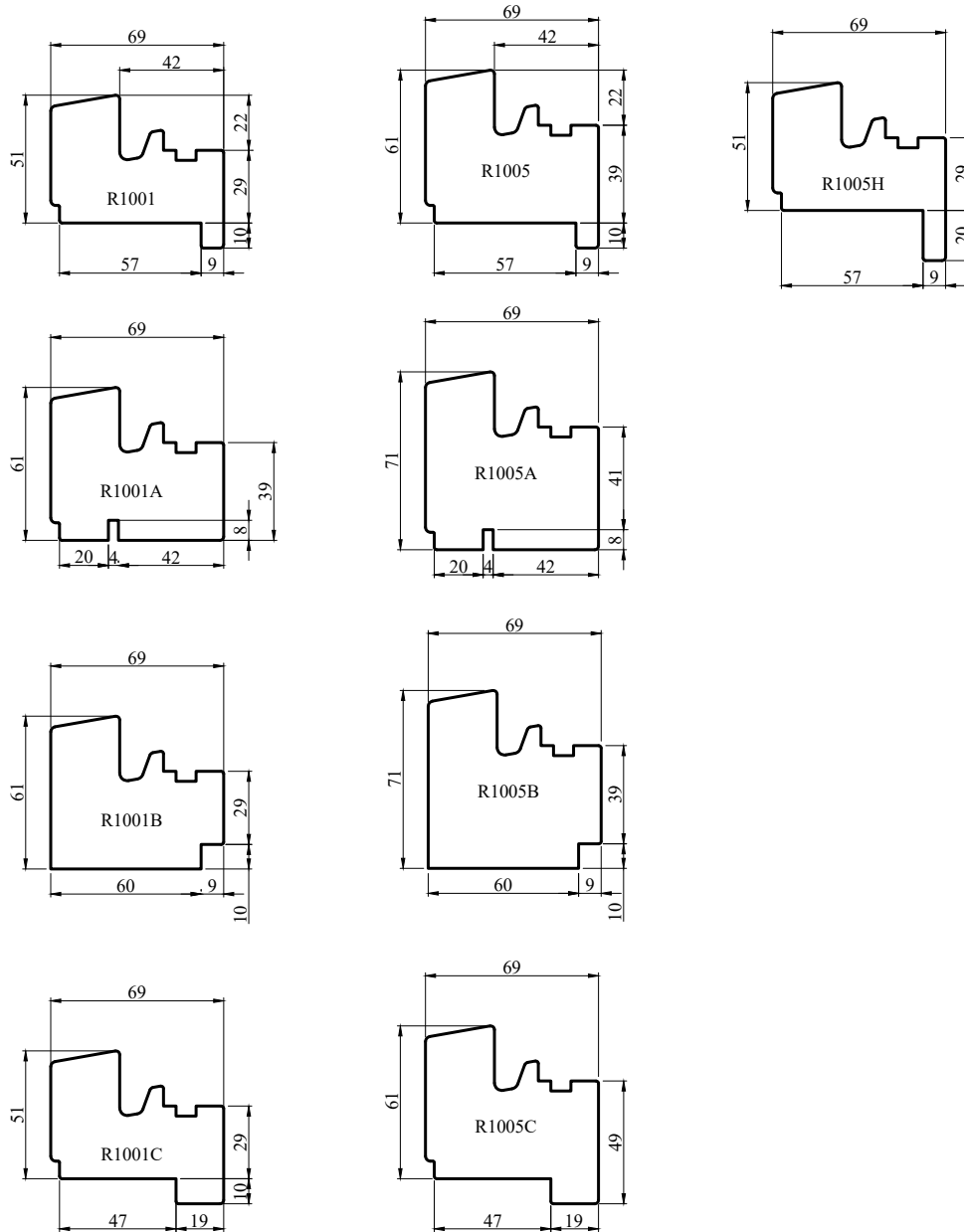

## Appui aluminium

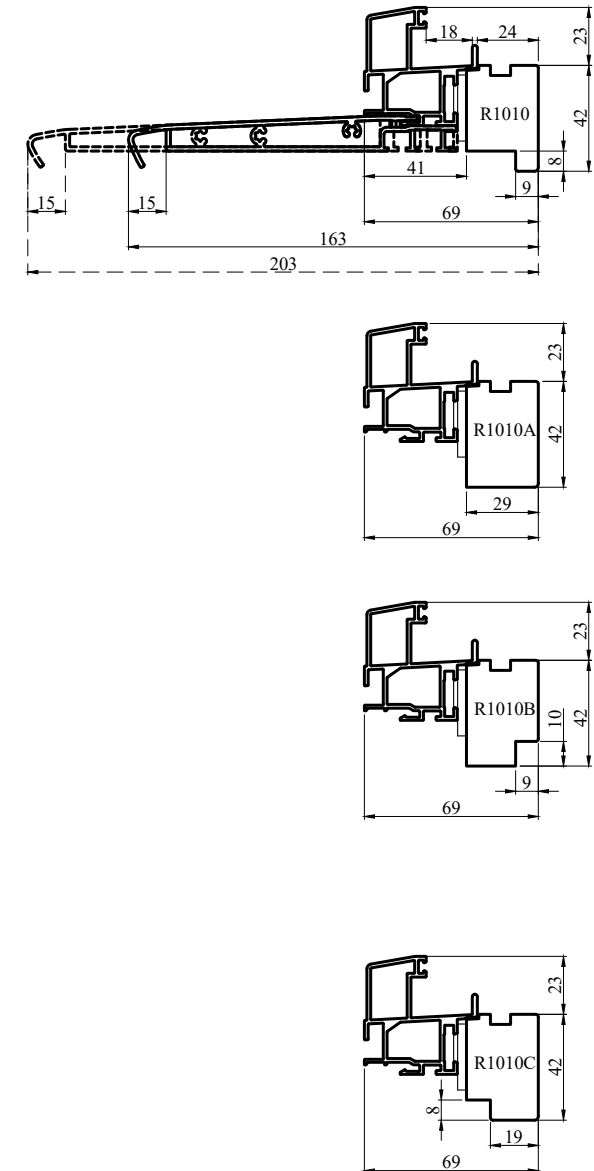

	Emplacement :			CE DOCUMENT EST LA PROPRIÉTÉ DES MENUISERIES ELVA. IL NE PEUT ÊTRE REPRODUIT OU COMMUNIQUÉ SANS SON AUTORISATION	Ind. 0
		Echelle : 1/3	Date : 22/05/2023	Des. : ML	N° plan : <b>PLC-SYMBIOPHONY-2</b>
<b>Gamme SYMBIOPHONY --- B04 - Appui réno &amp; alu</b>					

## Dormant standard

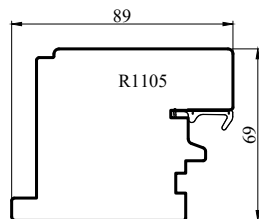
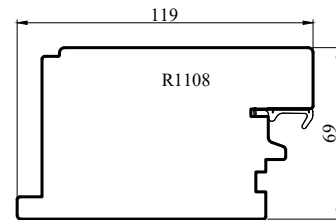
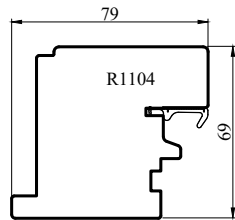
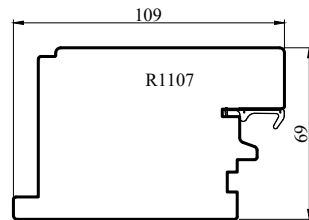
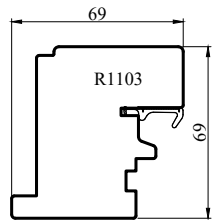
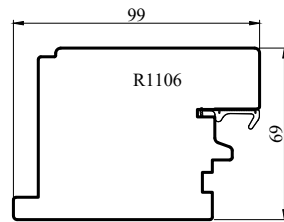
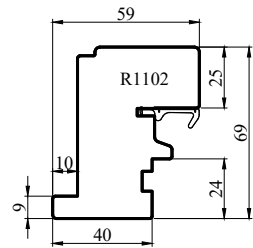

## Dormant droit

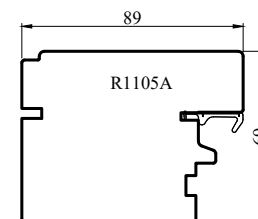
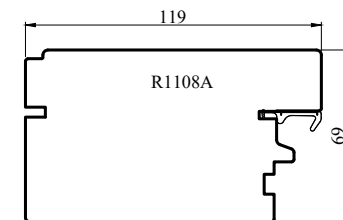
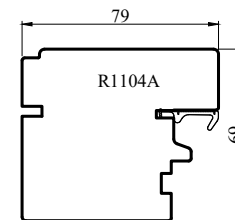
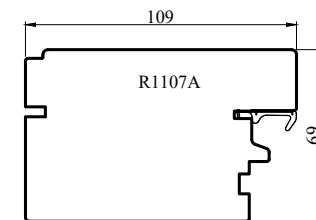
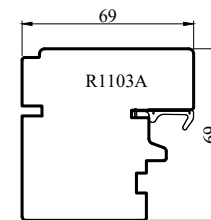
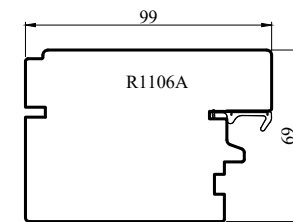
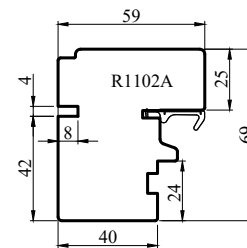

Emplacement :



Echelle : 1/3

Date : 22/05/2023

Des. : ML

CE DOCUMENT EST LA PROPRIETE DES MENUISERIES ELVA, IL NE PEUT ETRE REPRODUIT OU COMMUNIQUE SANS SON AUTORISATION

Ind. 0

N° plan : **PLC-SYMBIOPHONY-3**

**Gamme SYMBIOPHONY --- B04 - Dormant standard & droit**

## Dormant aile approfondie

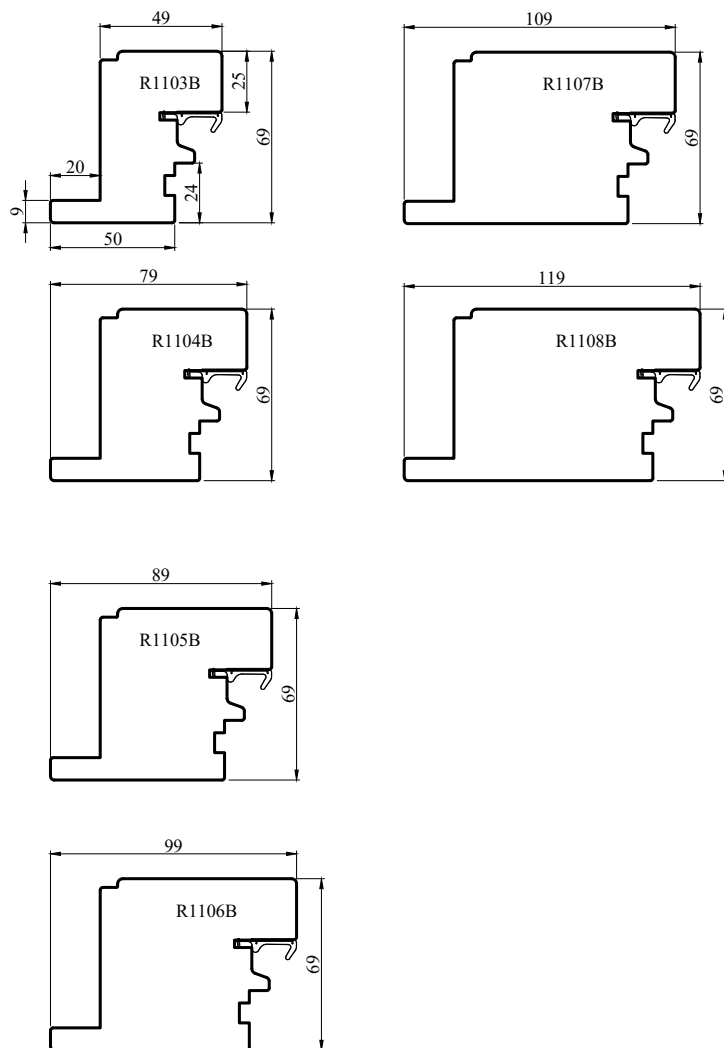

## Dormant aile épaissie

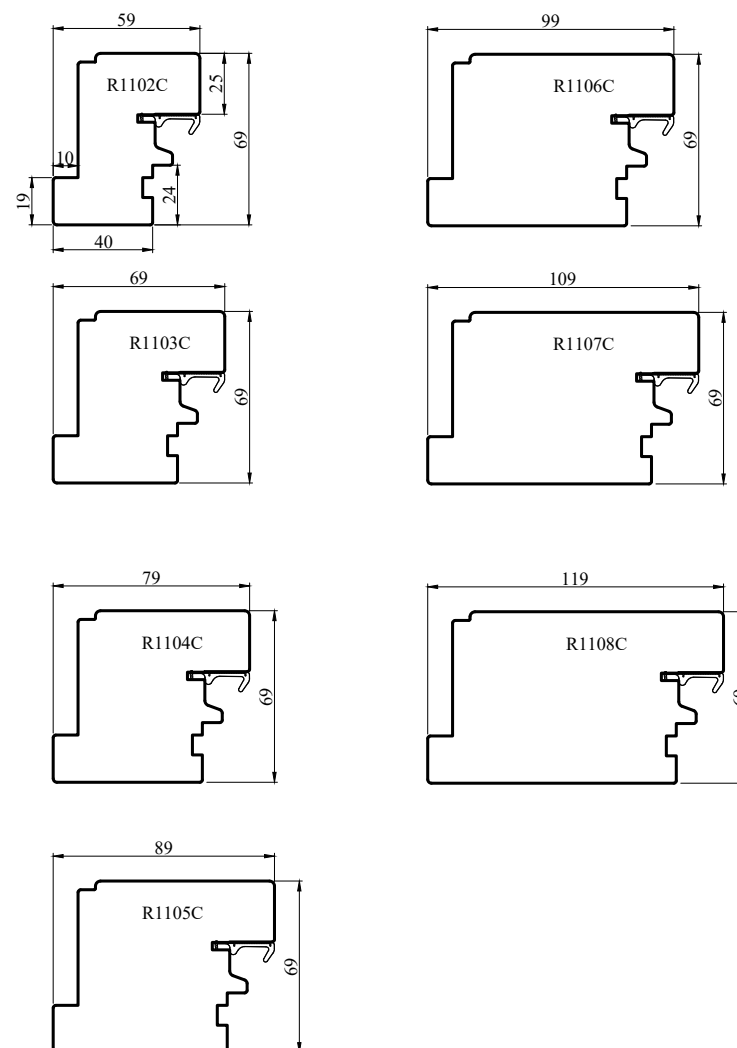

Emplacement :

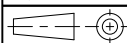

Echelle : 1/3

Date : 22/05/2023

Des. : ML

CE DOCUMENT EST LA PROPRIETE DES MENUISERIES ELVA. IL NE PEUT ETRE REPRODUIT OU COMMUNIQUE SANS SON AUTORISATION

Ind. 0

N° plan : **PLC-SYMBIOPHONY-4**

**Gamme SYMBIOPHONY --- B04 - Dormant aile élargie & épaissie**

## Dormant pour empilage

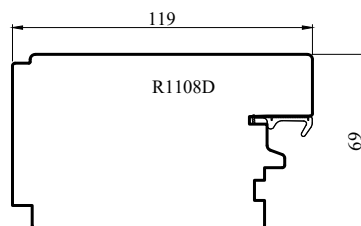
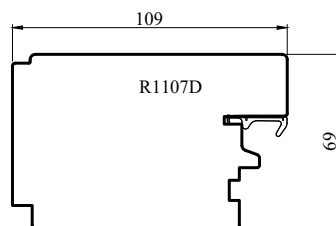
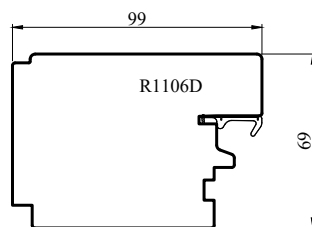
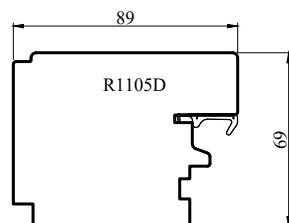
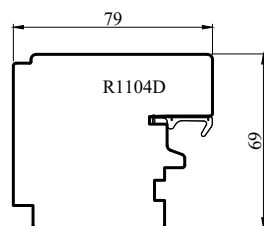
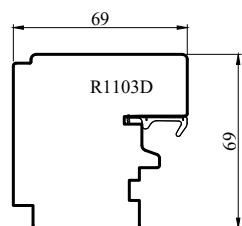
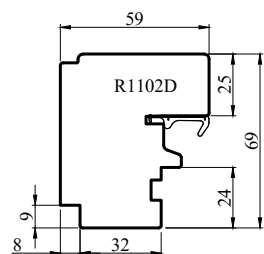

## Dormant ouverture extérieur

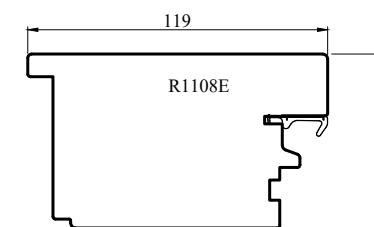
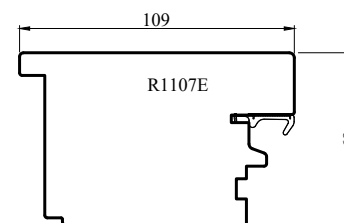
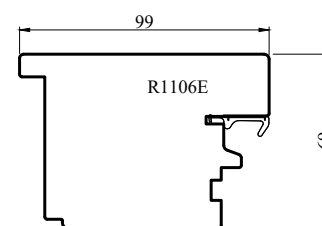
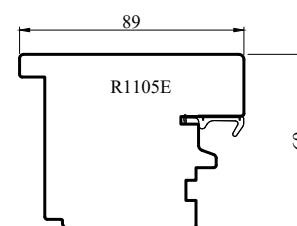
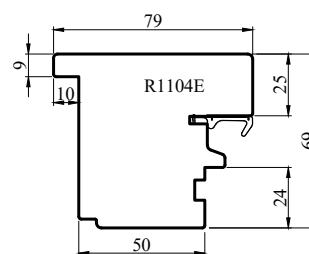

Emplacement :

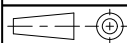

Echelle : 1/3

Date : 22/05/2023

Des. : ML

CE DOCUMENT EST LA PROPRIETE DES MENUISERIES ELVA, IL NE PEUT ETRE REPRODUIT OU COMMUNIQUE SANS SON AUTORISATION

Ind. 0

N° plan : **PLC-SYMBIOPHONY-5**

**Gamme SYMBIOPHONY --- B04 - Dormant empilé et aile extérieure**

# Meneau

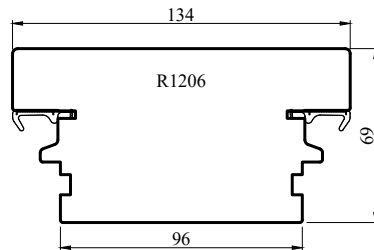
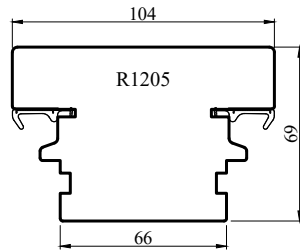
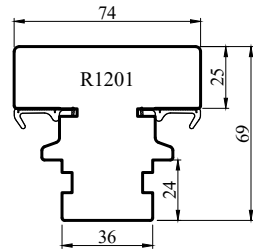

# Traverse intermédiaire dormante

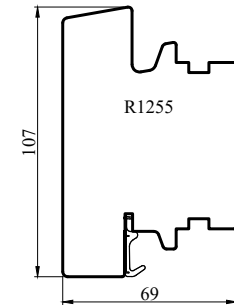
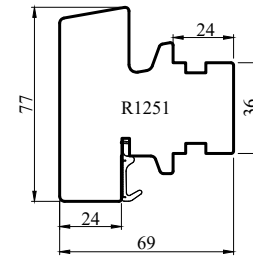

Emplacement :

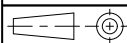

Echelle : 1/3

Date : 22/05/2023

Des. : ML

CE DOCUMENT EST LA PROPRIETE DES MENUISERIES ELVA, IL NE PEUT ETRE REPRODUIT OU COMMUNIQUE SANS SON AUTORISATION

Ind. 0

N° plan : **PLC-SYMBIOPHONY-6**

**Gamme SYMBIOPHONY --- B04 - Dormant Meneau & TID**

### Partie basse ouvrant

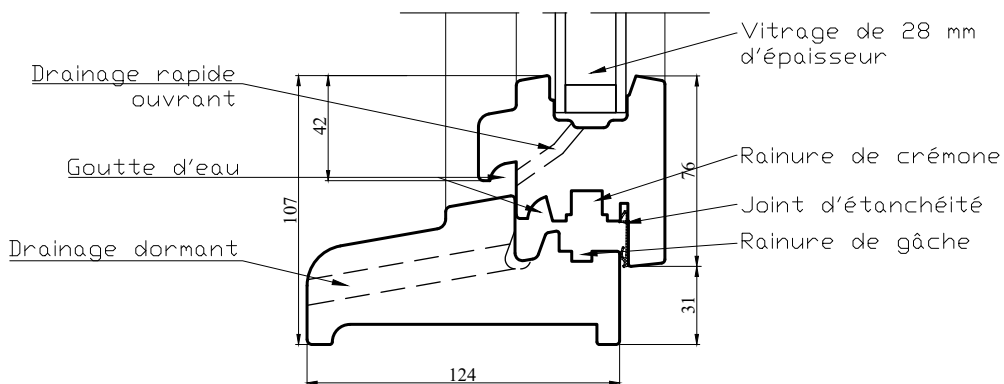

### Partie basse fixe

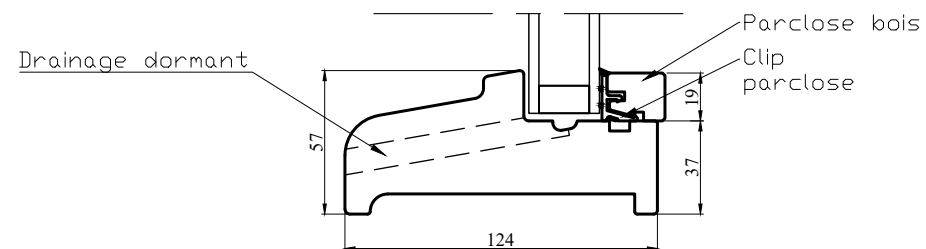

### Partie basse appui aluminium

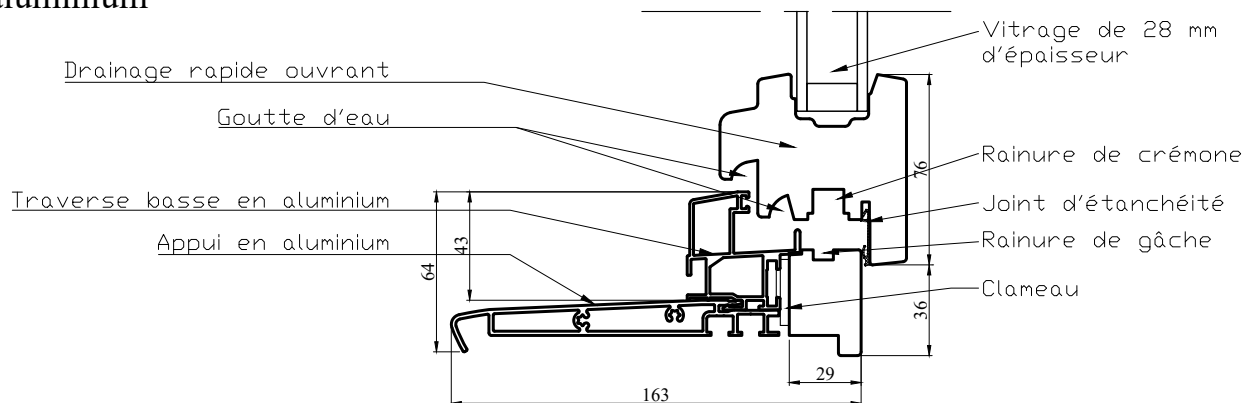

Emplacement :



Echelle : 1/3

Date : 22/05/2023

Des. : ML

CE DOCUMENT EST LA PROPRIETE DES MENUISERIES ELVA, IL NE PEUT ETRE REPRODUIT OU COMMUNIQUE SANS SON AUTORISATION

Ind. 0

N° plan : **PLC-SYMBIOPHONY-7**

**Gamme SYMBIOPHONY --- B04 - Assemblage**



# Ensemble partie basse

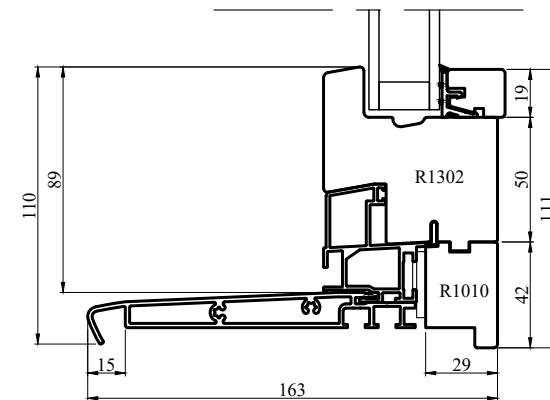
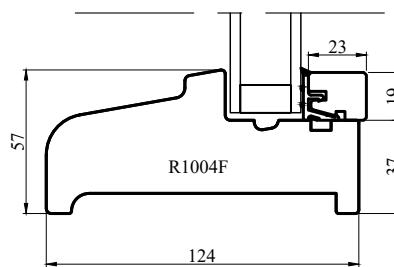
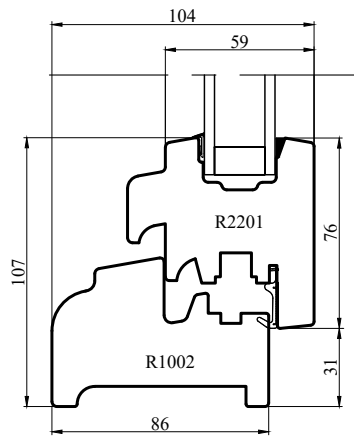
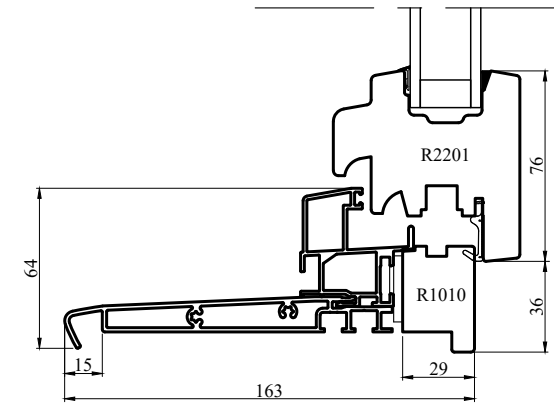
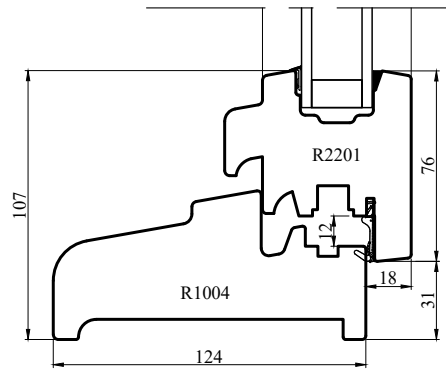
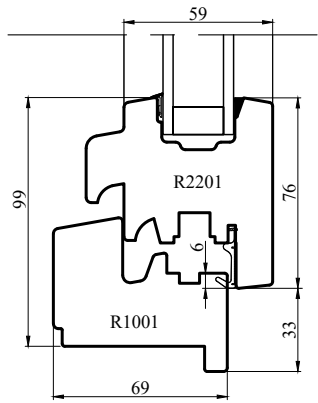

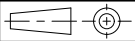
	Emplacement :		CE DOCUMENT EST LA PROPRIETE DES MENUISERIES ELVA. IL NE PEUT ETRE REPRODUIT OU COMMUNIQUE SANS SON AUTORISATION		Ind. 0
		Echelle : 1/3	Date : 22/05/2023	Des. : ML	N° plan : <b>PLC-SYMBIOPHONY-8</b>
<b>Gamme SYMBIOPHONY --- B04 - Assemblage partie basse</b>					

## Ensemble masse centrale

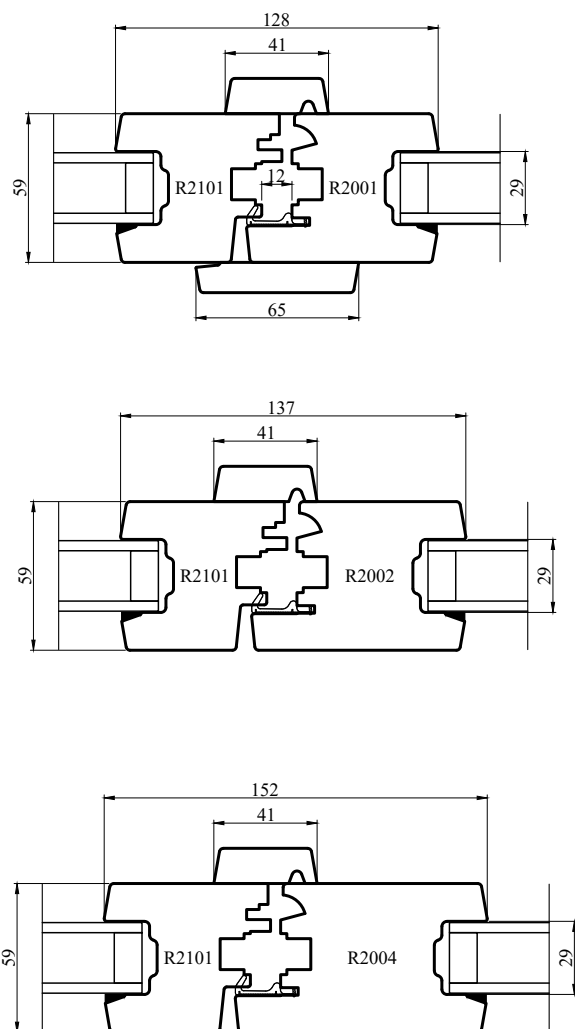

## Ensemble rive

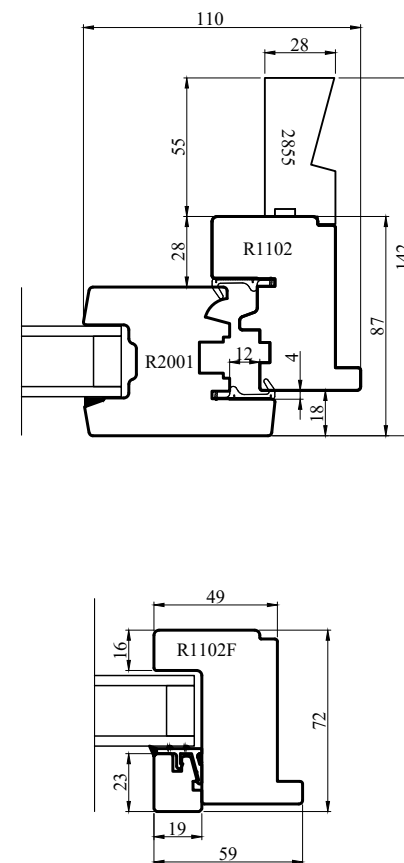

# Ensemble masse centrale avec meneau

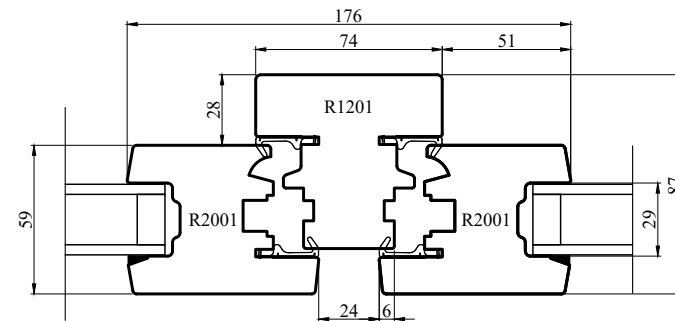
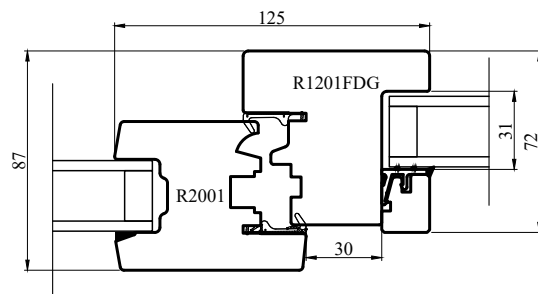
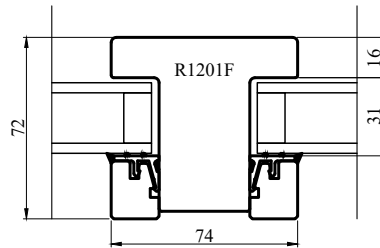

Emplacement :



Echelle : 1/3

Date : 30/05/2023

Des. : ML

CE DOCUMENT EST LA PROPRIETE DES MENUISERIES ELVA, IL NE PEUT ETRE REPRODUIT OU COMMUNIQUE SANS SON AUTORISATION

Ind. 0

N° plan : **PLC-SYMBIOPHONY-10**

**Gamme SYMBIOPHONY --- B04 - Assemblage masse centrale avec meneau**

### Ouvrant droit rainure de 29 mm

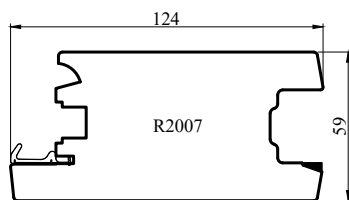
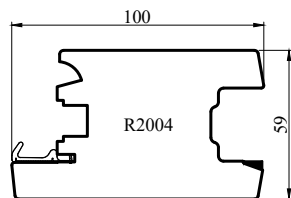
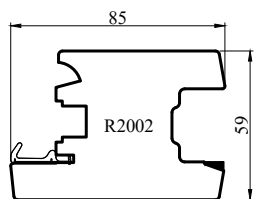
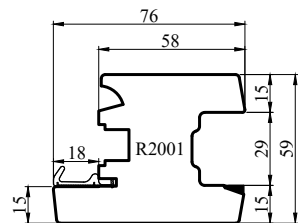

### Battement central

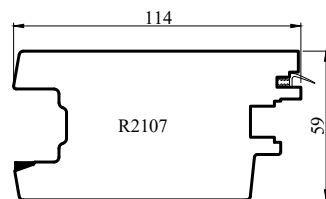
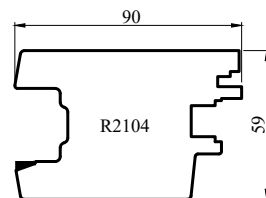
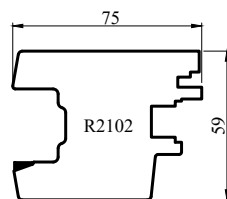
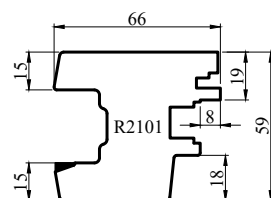

### Traverse basse

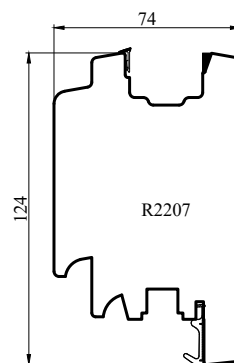
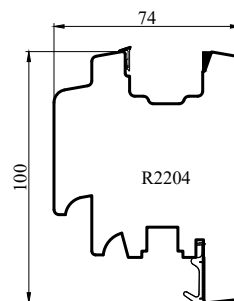
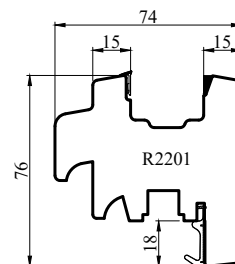

### Montant intermédiaire ouvrante

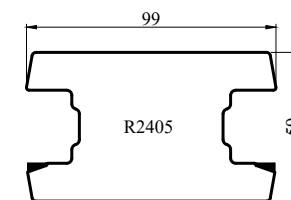
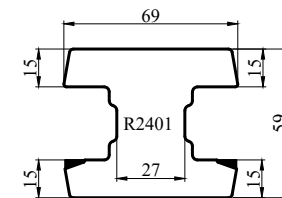

### Traverse intermédiaire ouvrante

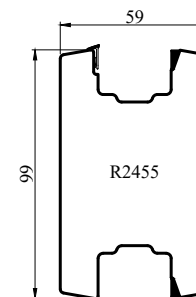
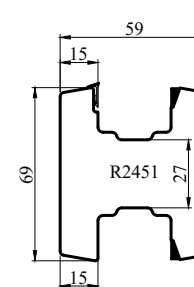

Emplacement :

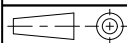

Echelle : 1/3

Date : 30/05/2023

Des. : ML

CE DOCUMENT EST LA PROPRIETE DES MENUISERIES ELVA, IL NE PEUT ETRE REPRODUIT OU COMMUNIQUE SANS SON AUTORISATION

Ind. 0

N° plan : **PLC-SYMBIOPHONY-11**

**Gamme SYMBIOPHONY --- B04 - Ouvrant droit R29**

### Ouvrant mouluré rainure de 29 mm

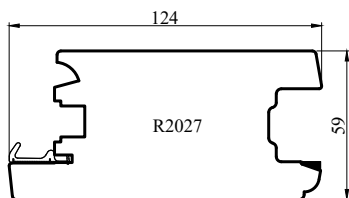
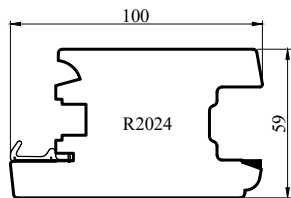
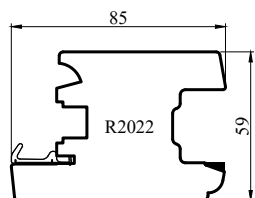
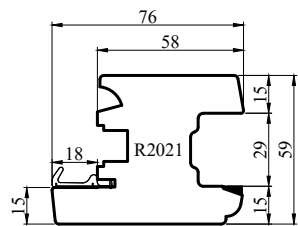

### Battement central

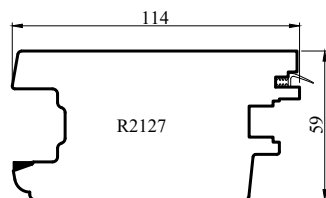
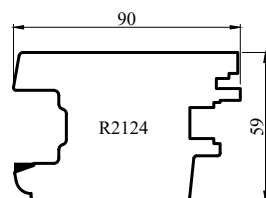
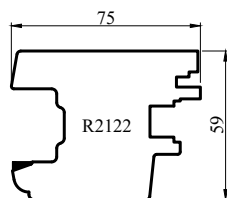
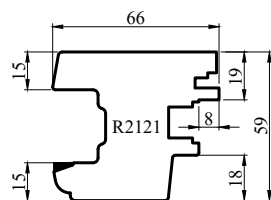

### Traverse basse

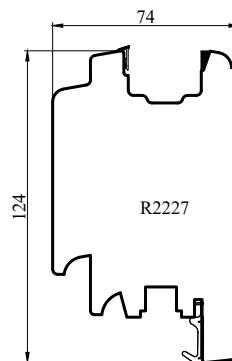
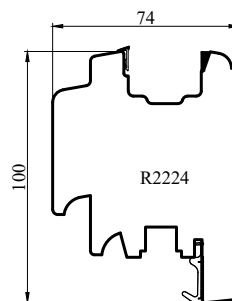
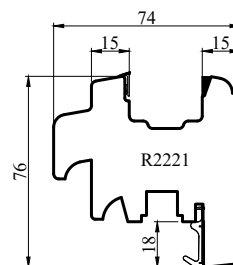

### Montant intermédiaire ouvrante

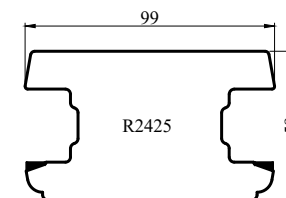
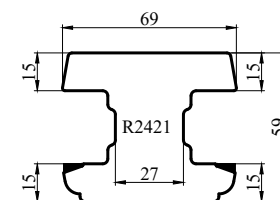

### Traverse intermédiaire ouvrante

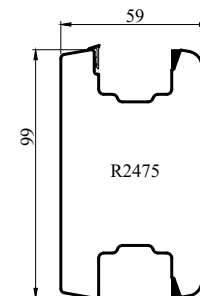
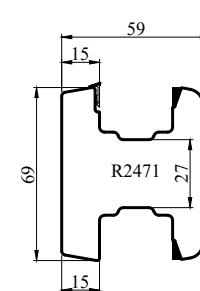

Emplacement :

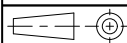

Echelle : 1/3

Date : 30/05/2023

Des. : ML

CE DOCUMENT EST LA PROPRIETE DES MENUISERIES ELVA, IL NE PEUT ETRE REPRODUIT OU COMMUNIQUE SANS SON AUTORISATION

Ind. 0

N° plan : **PLC-SYMBIOPHONY-12**

**Gamme SYMBIOPHONY --- B04 - Planche Ouvrant mouluré R29**

### Ouvrant 74 rainure de 47

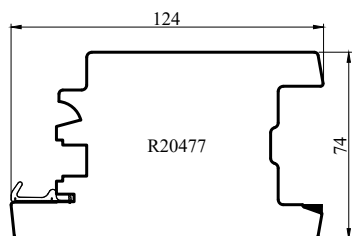
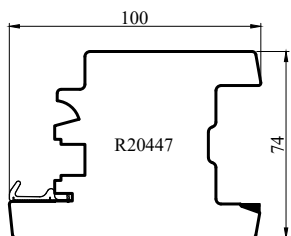
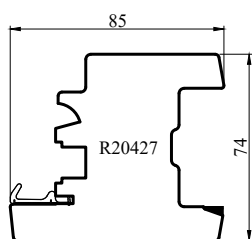
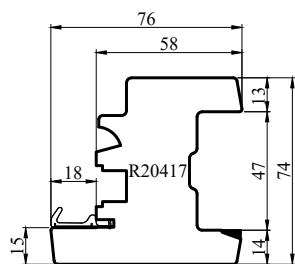

### Battement central

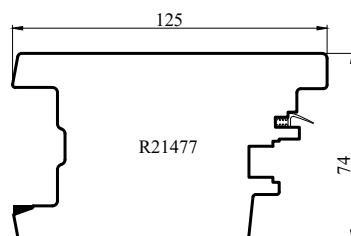
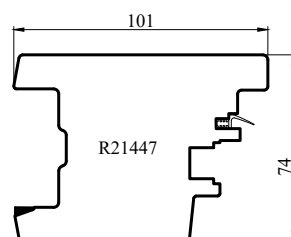
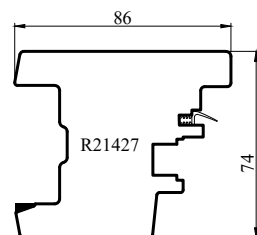
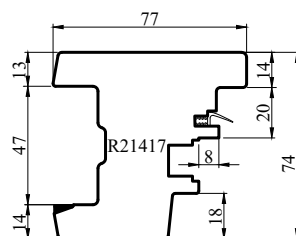

### Traverse basse

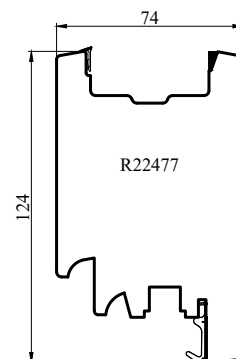
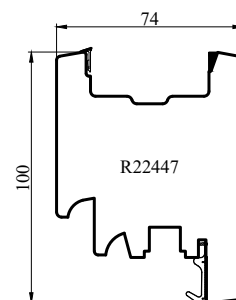
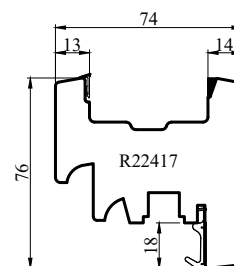

### Montant intermédiaire ouvrante

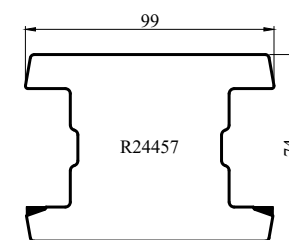
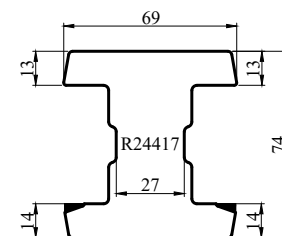

### Traverse intermédiaire ouvrante

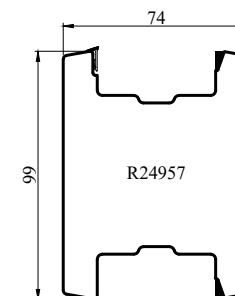
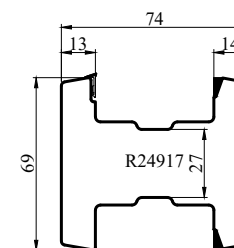

Emplacement :

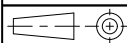

Echelle : 1/3

Date : 30/05/2023

Des. : ML

CE DOCUMENT EST LA PROPRIETE DES MENUISERIES ELVA. IL NE PEUT ETRE REPRODUIT OU COMMUNIQUE SANS SON AUTORISATION

Ind. 0

N° plan : **PLC-SYMBIOPHONY-13**

**Gamme SYMBIOPHONY --- B04 - Ouvrant 74 droit R47**